

Article number: 604144022020

Description: Timing belt pulley with hub
HTD 22 8M 20

Measures

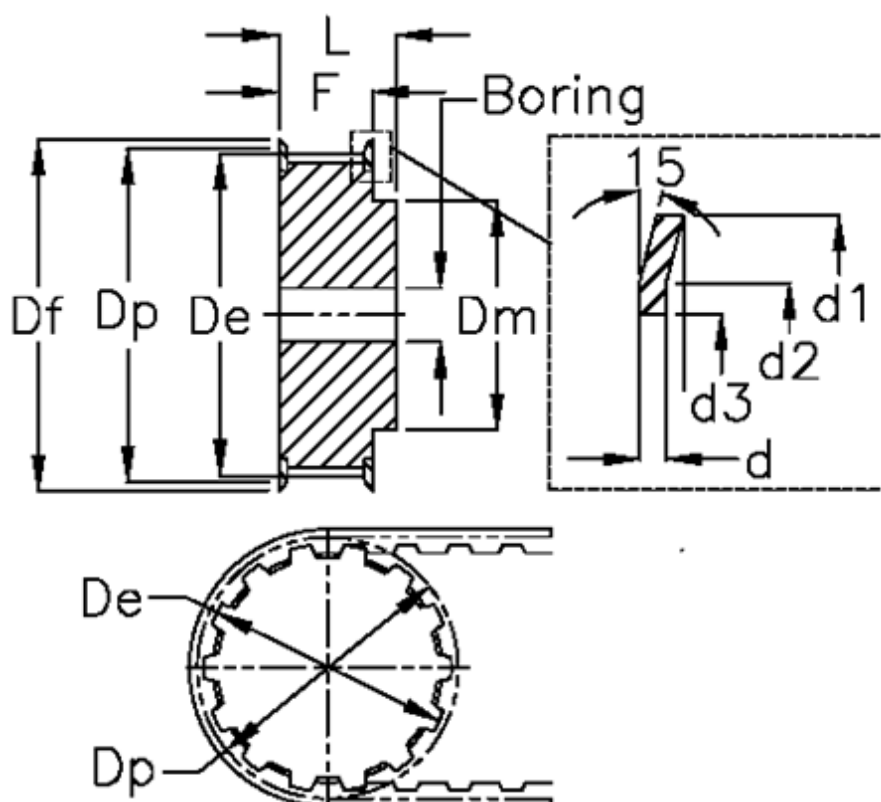

Bore = 12	Dp = 56.02
d = 1.5	F = 28
d1 = 60	Flange type = F22
d2 = 57	L = 38
d3 = 47	Tooth number = 22
De = 54.65	Type = 8M
Df = 60	Weight = 0.54
Dm = 43	Width = 20